

# WHAT DOES THE IDEAL 5G NETWORK LOOK LIKE?

5G holds the dual promise of unprecedented services and unparalleled user experience. 5G will not be just another G, because it will go beyond capacity as we know it and require networking, as we know it, to change.

4G's main service was mobile broadband, hence the focus on the capacity and connectivity offered by the radio access network (RAN). The transport network provided MBH (mobile backhaul) as “dumb, nailed-up, capacity pipes”, which linked the RAN to the services and applications in the core of the network. In general, the architecture of choice for 4G MBH was a physical ring supporting logical hub-and-spoke connectivity.

Whereas the transition from 3G to 4G was a mere ‘baby step’ in evolutionary terms, the transition to 5G will need to be different. To truly exploit the full potential of 5G will require a giant leap in every sense. And with it comes the potential to offer a vast array of new telecoms services to individuals, businesses, enterprise and mission-critical industries.

But to achieve this, the 5G transport network has to ditch “dumb pipes” in favor of a dynamic, yet deterministic, service-aware and cost-effective transport network. One that allows 5G to become a universal services platform, through which service providers can offer the full range of telecoms services to anyone who needs them.

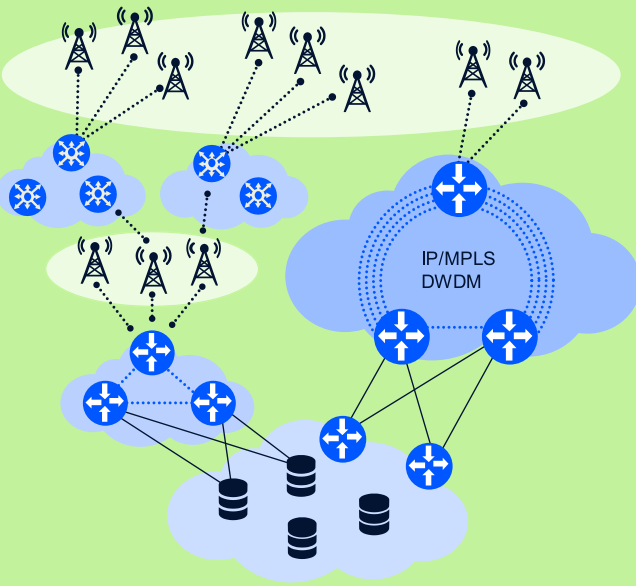

TRANSPORT REQUIREMENTS FOR 5G	
Ratio of aggregation / core nodes per access nodes	1:10-30
Station connectivity	nx10G/25G
Bandwidth of access ring links	50G/100G
Bandwidth of backbone links	nx100G
Point of traffic aggregation	Nearest point
MBH technologies	IP/MPLS, FlexE, SR-TE, VPN+
Main focus on	Service performance

In other words, the transport network needs to evolve into an agile, flexible and dynamic connectivity fabric. One that offers superfast 5G mobile broadband services when required, as well as being capable of providing the determinism to support mission and business-critical services. One that provides a platform capable of delivering connectivity to both wireless and wireline access technologies, thereby taking the 5G network beyond the purely wireless domain.

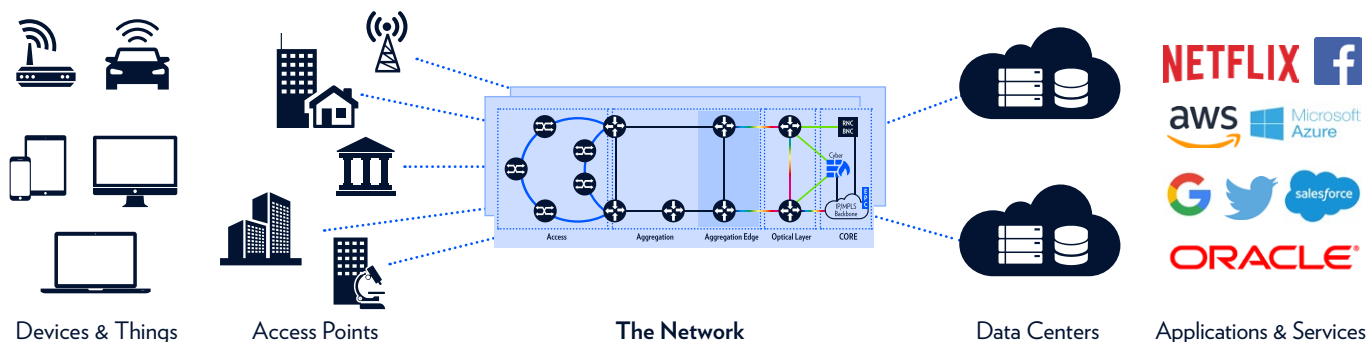

## MORE SERVICE ORIENTATED

As mentioned, the ideal 5G network will provide a universal service platform for all service types. The transport network domain will provide the connectivity fabric to link the access network to a dynamic, disaggregated mobile core.

The transport layer will require service-orientated, operations software to provide the intent-driven linkage between the service requests coming from the orchestration layer and the configuration required in the transport layer. The operations software manages the entire lifecycle of the network slices and the services running across these slices. It proactively ensures the services delivered across the connectivity fabric meet the service parameters and policies, and adapts the network slices and service architecture as network needs and demands change

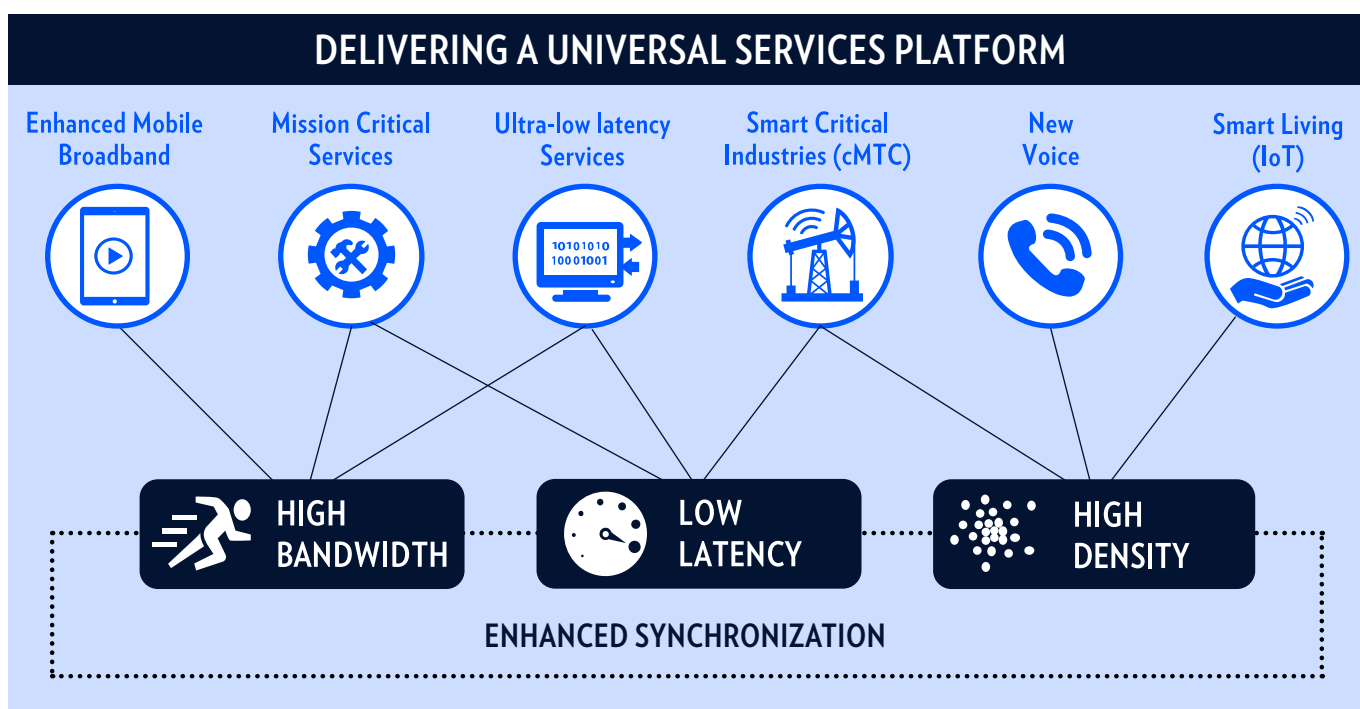

5G services will need higher bandwidth, lower latency transport. This can only be achieved with a fully integrated optical and packet transport network, with the packet layer being the ubiquitous way to flexibly transport IP services and the optical layer being the way to offer lowest latency, lowest cost-per-bit for transport and transport determinism.

Each domain in the 5G network will have its own domain manager and a service orchestrator, which will coordinate these domain managers to provide end-to-end control across the entire 5G network. The service orchestrator will configure the network, via the domain managers, to provide network slices to meet the diverse parameters and policies needed for each service type.

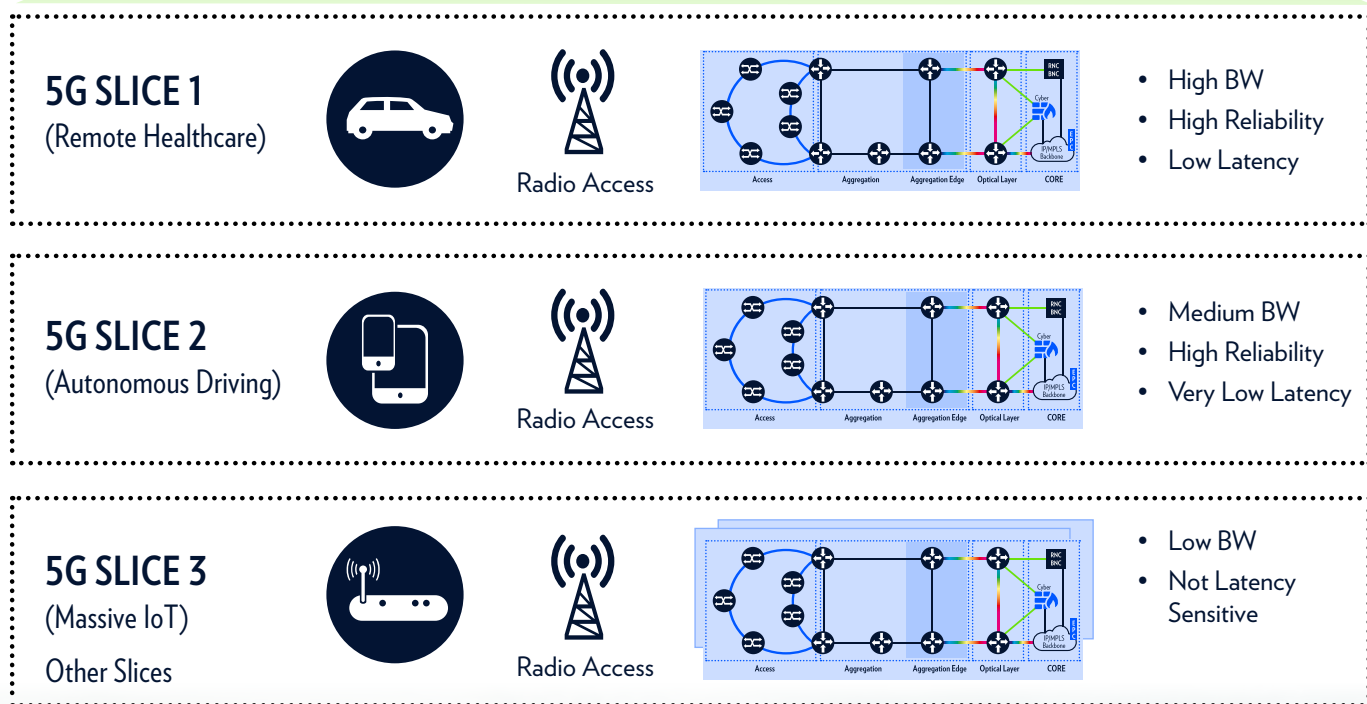
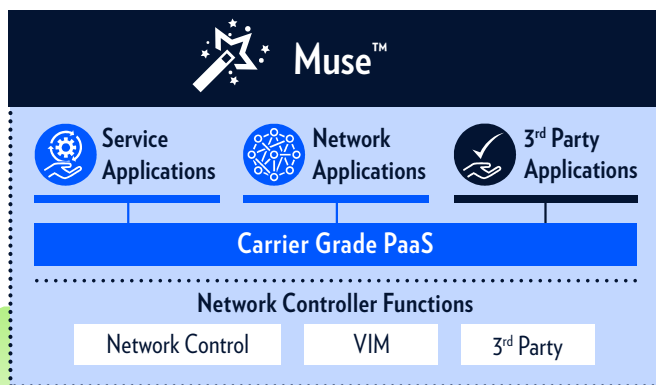

# MORE DYNAMIC

To support a vast range of diverse, dynamic, assured services, the 5G connectivity fabric has to provide the capacity, connectivity and compute functionality, wherever and whenever it's needed in the network. SDN will provide dynamic capacity and connectivity as, and when, it is required; while NFV will allow the flexible allocation of compute functionality, when and where it's needed.

Integrating NFVi into the transport network can provide a fully carrier-class platform able to support the powerful MEC functionality required for low-latency, high-bandwidth services like autonomous vehicles, video surveillance or remote surgery. The domain manager ensures that connectivity meets all of the policies and parameters defined for the service.

The service layer has to be dynamic enough to support on-demand, autonomous services for a whole range of service types. This requires an IP transport layer able to offer both dynamic and deterministic services. Segment Routing provides this IP transport, and a centralized PCE calculates the traffic path across the service layer and the underlay, based on service/application policies and parameters.



## Muse™ SERVICE & NETWORK ORCHESTRATOR

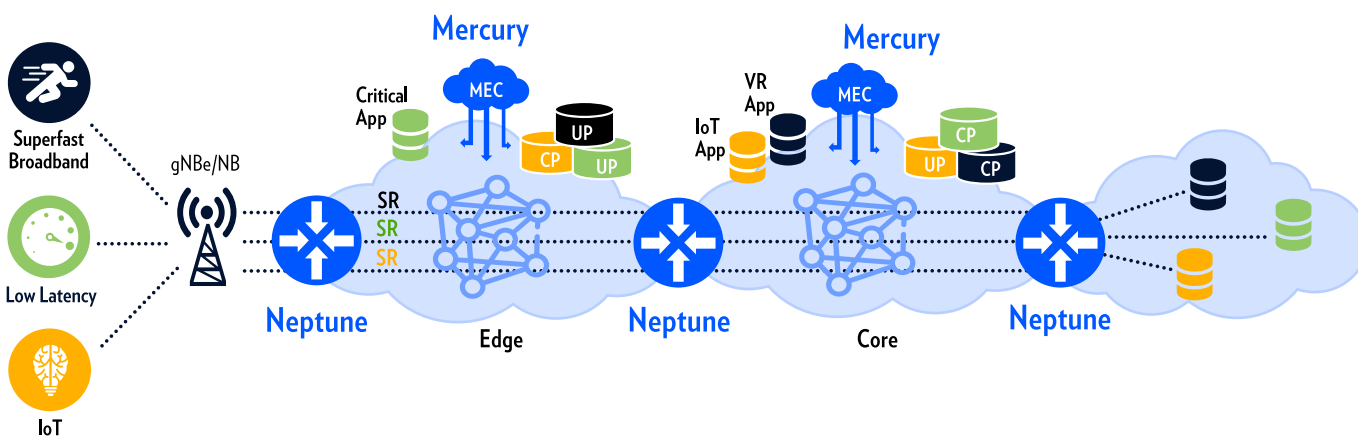

# YET DETERMINISTIC

Business-critical or mission-critical services require precise, deterministic behavior from the network with guaranteed availability. This requires a deterministic underlay network and the respective IP layer mentioned before. So the ideal 5G network uses new transport technologies (FlexE, Time Sensitive Networking, FlexOTN) to provide flexible determinism in the underlay.



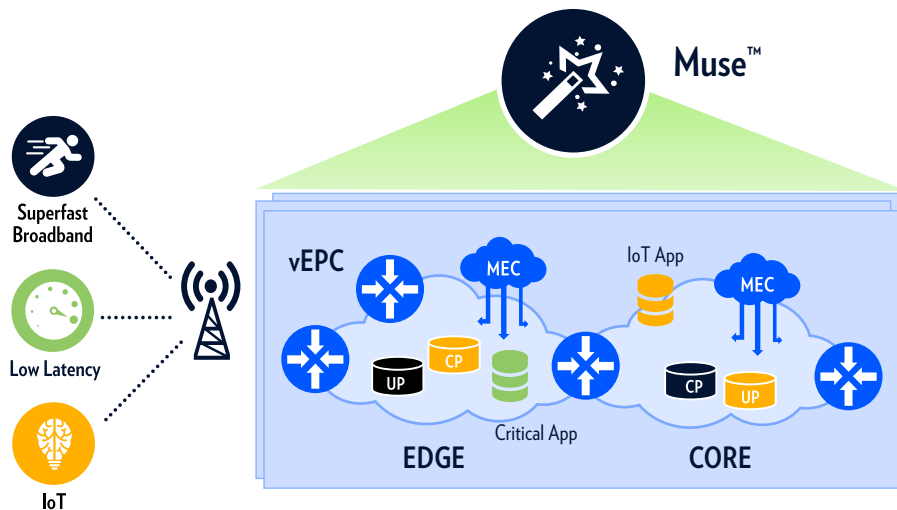

- Intent driven, autonomous activation
- Predictive planning
- Proactive assurance
- Analytics and guaranteed SLAs
- SR, PCE, MANO, SDN

- Dynamic service delivery
- Deterministic performance
- Flexible Bandwidth
- Elastic Connectivity
- Configurable Latency

- High reliability
- Compute where needed
- Security
- Seamlessly integrated IP and Optical transport

## BRINGING IT ALL TOGETHER

Bring these things together and what do you have? A service-oriented network, with dynamic delivery (via SDN and NFV) and a deterministic underlay. A fully integrated packet and optical transport network that provides the dynamic connectivity fabric required for mobile network operators to use 5G as a universal services platform. A connectivity fabric that provides the assured, deterministic transport required to support superfast broadband, along with business and mission-critical services. Et voila!

Contact us for more information about how ECI can help you meet and overcome the 5G network connectivity challenge



### ABOUT ECI

ECI is a global provider of ELASTIC network solutions to CSPs, utilities as well as data center operators. Along with its long-standing, industry-proven packet-optical transport, ECI offers a variety of SDN/NFV applications, end-to-end network management, a comprehensive cyber security solution, and a range of professional services. ECI's ELASTIC solutions ensure open, future-proof, and secure communications. With ECI, customers have the luxury of choosing a network that can be tailor-made to their needs today – while being flexible enough to evolve with the changing needs of tomorrow. For more information, visit us at [www.ecitele.com](http://www.ecitele.com)